

## radino nRF8001

The In-Circuit radino nRF8001 combines an **Arduino Micro** with **Bluetooth-Low-Energy(BLE)** in a small form-factor **EMC-compliant** enclosure.

It's part of the radino-series, which provides full-Arduino-compatible wireless communication devices in a small form factor, all **pin-compatible** to each other.

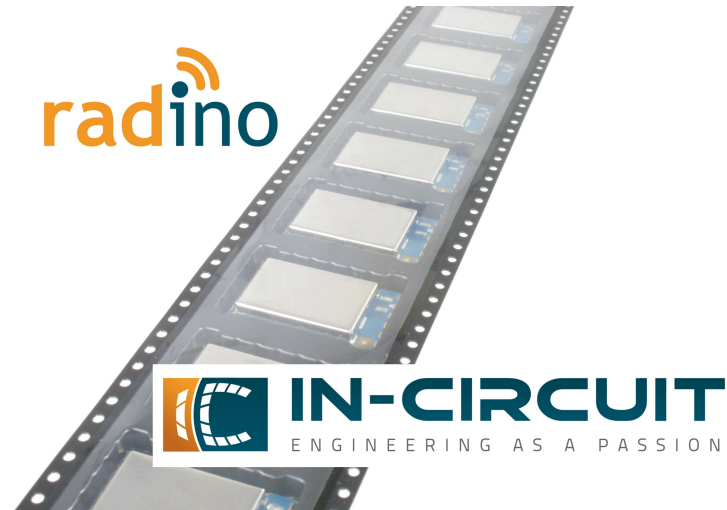

## Features

- Arduino-compatible (**Arduino Micro** / Leonardo)
- **Bluetooth low energy** SDK for Arduino by Nordic Semicond. (<https://devzone.nordicsemi.com/arduino/>)
- Bluetooth v4.0 compliant Protocol Stack (BLE)
- 15 GPIOs (5 PWM, 5 Analog IN)
- I<sup>2</sup>C, SPI, UART
- USB (HUID Keyboard & Mouse, virtual UART)
- High-Performance, Low-Power Microcontroller
- GATT, GAP, L2CAP, SMP Bluetooth low energy Profile

## Applications

- Sport and fitness sensors
- Health care sensors
- Proximity sensors
- Personal User Interface Devices (PUIID)
- Remote controls
- Security Tags
- Household sensors and collector devices
- Mobile accessories
- Data logging
- Any Arduino project

For more information visit: <http://www.in-circuit.de>  
<http://www.radino.cc>

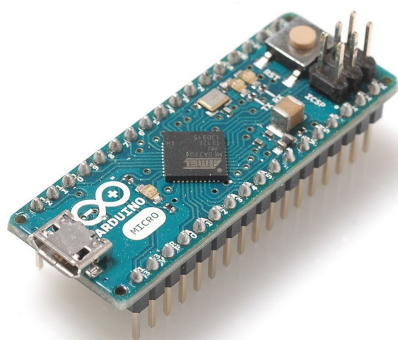

Arduino Micro



BLE

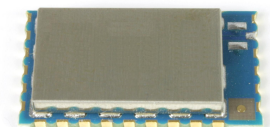

radino nRF8001

## Overview

The In-Circuit radino nRF8001 combines an Arduino Micro with Bluetooth low energy(BLE). Despite its small form factor, the radino nRF8001 offers great connectivity. It's a perfect core for any BLE project, almost all GPIOs, interfaces and connections of the ATmega32U4 can be connected to external circuitry.

A modified Arduino Micro Bootloader is pre-installed on the radino nRF8001. This enables easy programming by using the Arduino IDE (<http://www.arduino.cc/>). Refer to section “First steps with radino” for more information.

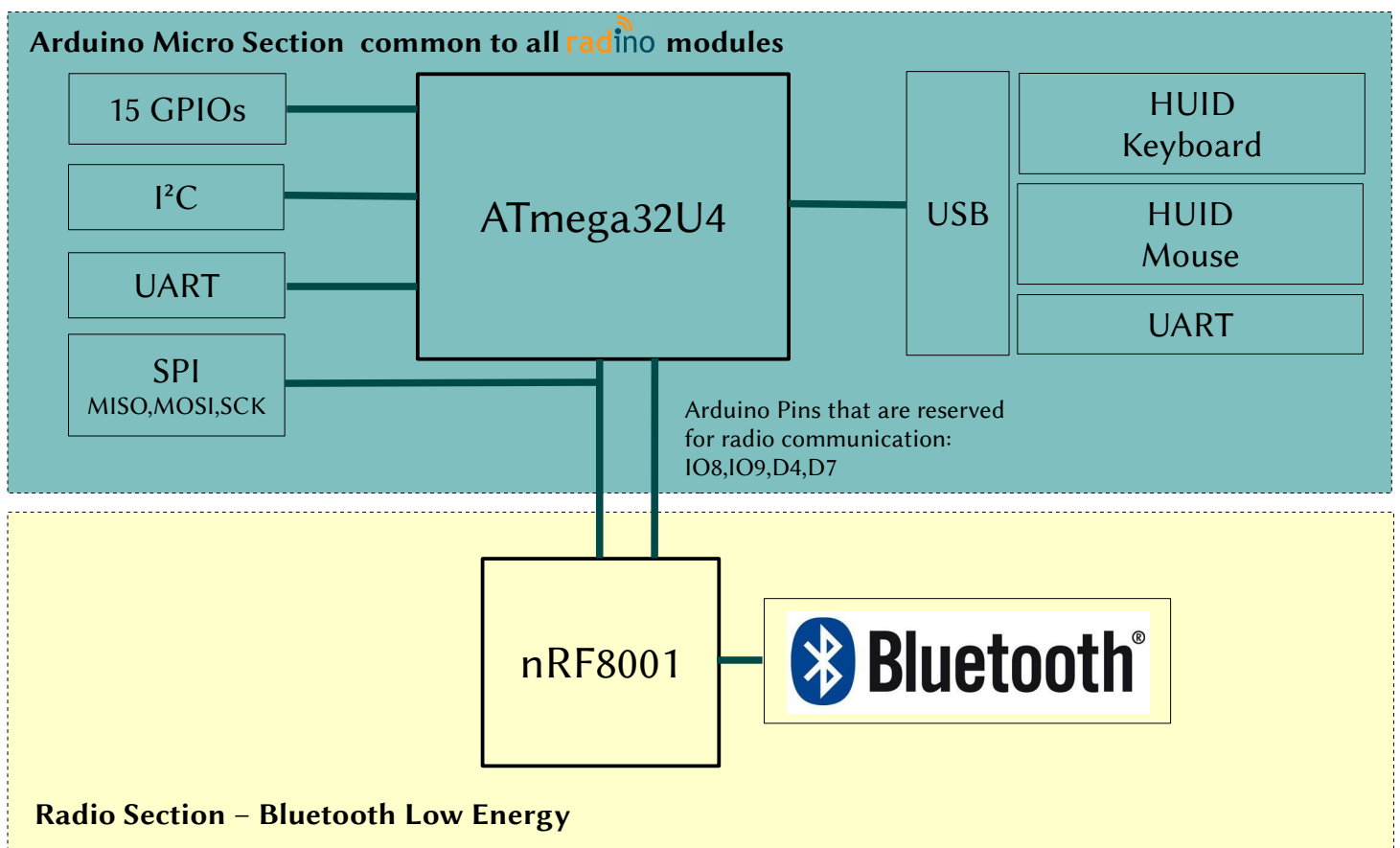

## Pinout and Terminal Description



Top View

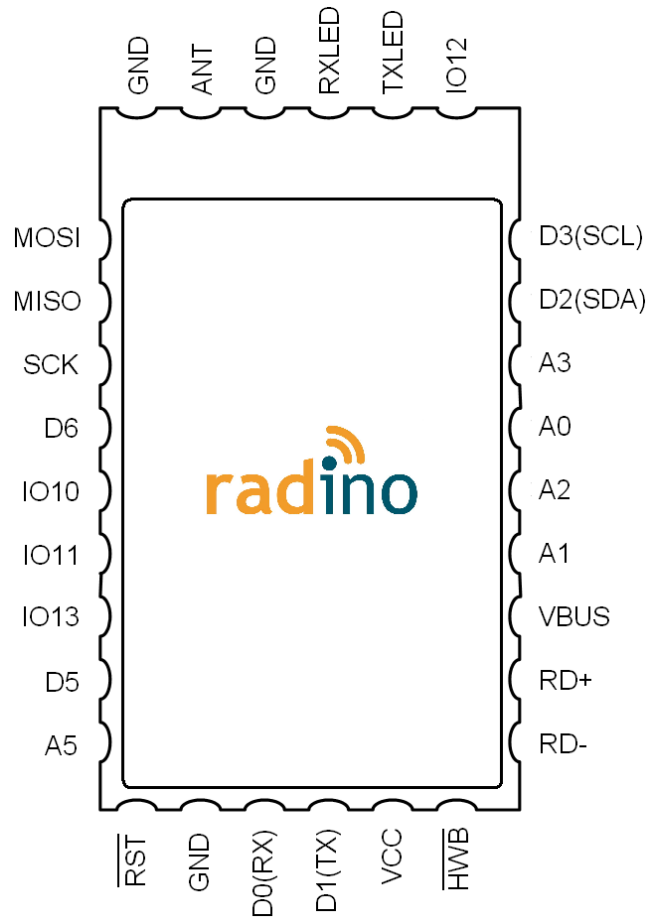

radino Pin No.	Name	Arduino Pin No.	Atmega32U4 Port	Description / Function (bold = main function)
1	MOSI	16	PB2	<b>SPI-MOSI</b> (also connected to internal radio chip) GPIO; PCINT2
2	MISO	14	PB3	<b>SPI-MISO</b> (also connected to internal radio chip) GPIO; PCINT3
3	SCK	15	PB1	<b>SPI-SCK</b> (also connected to internal radio chip) GPIO; PCINT1
4	D6	6 A7	PD7	GPIO; PWM ADC10
5	IO10	10 A10	PB6	GPIO; PWM; PCINT6; ADC13
6	IO11	11	PB7	GPIO; PWM; PCINT7; UART-RTS
7	IO13	13	PC7	GPIO; PWM
8	D5	5	PC6	GPIO; PWM
9	A5	A5 23	PF0	ADC0 GPIO
10	Reset	-	Reset	Reset of Atmega32U4
11	GND	-	GND	Ground

radino Pin No.	Name	Arduino Pin No.	Atmega32U4 Port	Description / Function (bold = main function)
12	D0(RX)	0	PD2	<b>UART-RX</b> GPIO; INT2
13	D1(TX)	1	PD3	<b>UART-TX</b> GPIO; INT3
14	V <sub>CC</sub>	-	VCC	Power supply
15	$\overline{\text{HWB}}$	-	PE2	Hardware-Bootloader-Enable; Low-Active
16	RD-	-	RD-	USB-D-
17	RD+	-	RD+	USB-D+
18	V <sub>BUS</sub>	-	VBUS	USB voltage IN ( <b>VBUS will NOT supply the module. Connect VCC on Pin 14 to supply the module.</b> )
19	A1	A1 19	PF6	ADC6 GPIO
20	A2	A2 20	PF5	ADC5 GPIO
21	A0	A0 18	PF7	ADC7 GPIO
22	A3	A3 21	PF4	ADC4 GPIO
23	D2(SDA)	2	PD1	<b>SDA</b> GPIO; INT1
24	D3(SCL)	3	PD0	<b>SCL</b> GPIO; PWM; INT0
25	IO12	12 A11	PD6	GPIO; PWM ADC9
26	TXLED	-	PD5	<b>TXLED</b> GPIO; UART-CTS
27	RXLED/ $\overline{\text{SS}}$	17	PB0	<b>RXLED</b> GPIO; SS; PCINT0
28	GND	-	GND	Ground
29	ANTENNA	-	-	Antenna pin
30	GND	-	GND	Ground
-	RADIO_RST	4	PD4	<b>connected to internal radio chip</b> Signal: $\overline{\text{Reset}}$
-	RADIO_ACT	7	PE6	<b>connected to internal radio chip</b> Signal: Active
-	RADIO_RDY	8	PB4	<b>connected to internal radio chip</b> Signal: $\overline{\text{RDY}}$
-	RADIO_REQ	9	PB5	<b>connected to internal radio chip</b> Signal: $\overline{\text{REQ}}$
-	A4	A4	PF1	<b>Not connected</b>

## Electrical Characteristics

### Absolut Maximum Ratings

Note: These are absolute maximum ratings beyond which the module can be permanently damaged. These are not maximum operating conditions.

Rating	Min	Max	Unit
Storage Temperature	-65	125	°C
$V_{CC}$	-0.3	3.6	V
$V_{BUS}$	-0.5	6	V
$\overline{\text{Reset}}$	-0.5	13	V
Other Terminal Voltages	-0.3	$V_{CC}+0.3$	V

### Recommended Operating Conditions

Environmental conditions

Rating	Min	Typ.	Max	Unit
Operating Temperature	-40		85	°C
$V_{CC}$	2.7	3.3	3.6	V

DC Characteristics

$T_A = -40^\circ\text{C}$  to  $85^\circ\text{C}$ ,  $V_{CC} = 2.7\text{V}$  to  $3.6\text{V}$  (unless otherwise noted)

Symbol	Rating	Min	Typ.	Max	Unit
$V_{IL}$	Input Low Voltage, except $\overline{\text{Reset}}$ pin	-0.3		$0.2V_{CC}-0.1\text{V}$	V
$V_{IL2}$	Input Low Voltage, $\overline{\text{Reset}}$ pin	-0.5		$0.1V_{CC}$	V
$V_{IH}$	Input High Voltage, except $\overline{\text{Reset}}$ pin	$0.2V_{CC}+0.9\text{V}$		$V_{CC} + 0.5$	V
$V_{IH1}$	Input High Voltage, $\overline{\text{Reset}}$ pin	$0.9V_{CC}$		$V_{CC} + 0.5$	V
$V_{OL}$	Output Low Voltage			0.5	V
$V_{OH}$	Output High Voltage	2.3			V

## Current consumption parameters

Operation conditions:  $V_{CC}=3.3V$ ,  $T_A=40^{\circ}C$  to  $+85^{\circ}C$ .

Symbol	Rating	Min	Typ.	Max	Unit
$I_{on}$	Full on	---	20	---	mA
$I_s$	Mean Current with transmission 1x per sec. Duty Cycle: On 10ms / Sleep 990ms Processor sleeps in power down mode and wakes up by interrupt	---	20	---	$\mu A$
	TBD				

## First steps with radino

The core of radino is an Arduino Micro, so the programming is as easy as programming an Arduino Micro. Visit <http://www.arduino.cc/> for more information about the Arduino project.

### 1. Download & Install Arduino IDE

Arduino IDE is the development environment for Arduino. It's recommended to use this IDE when developing software for an Arduino-based module like radino. Nevertheless you can also use tools like Atmel Studio or any similar tool for Atmel microcontrollers to program these devices. (If they are based on an Atmel microcontroller like ATmega32U4 on radino).

→ Visit <http://www.arduino.cc/en/Main/Software> and download the latest version of Arduino IDE  
(We can't guarantee full functionality with BETA builds of Arduino IDE)

→ Install Arduino IDE on your computer

Arduino IDE requires a main Sketch-folder where new sketches/projects will be saved to by default. Also all additional libraries and hardware-files have to be put into this folder to be recognized by the Arduino IDE.

Default paths for this Sketch-folder are:

My Documents\Arduino  
C:\Documents and Settings\yourUserName\My Documents\Arduino  
C:\Users\yourUserName\Documents\Arduino

German computers:  
Eigene Dateien\Arduino  
C:\Dokumente und Einstellungen\ihrBenutzerName\Eigene Dateien\Arduino  
C:\Benutzer\ihrBenutzerName\Eigene Dateien\Arduino

You can also define a specific path when installing Arduino IDE.

→ Now start Arduino IDE. If installed properly, a window like this should open:

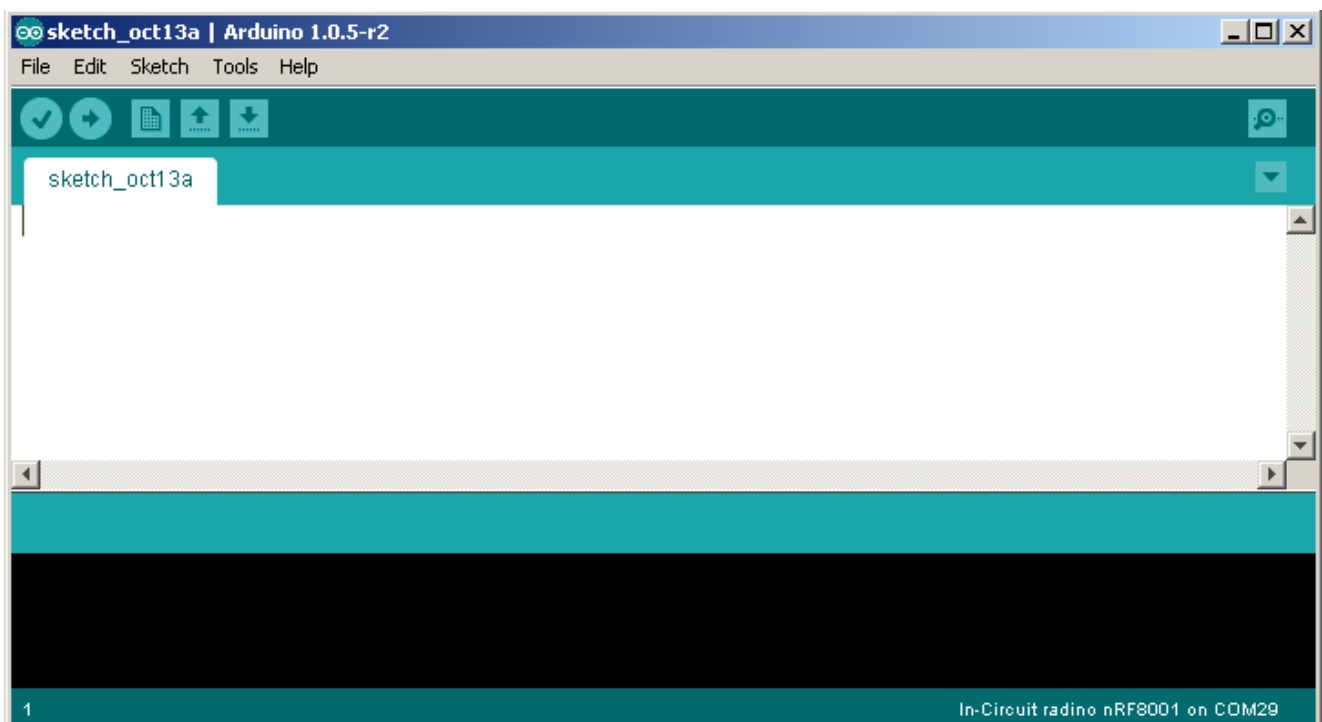

## 2. Download & Install radino support files

We provide a general Arduino support package for all our Arduino based products, which also includes support for the radino series. This includes required libraries, hardware files and example sketches for an easy start with radino

→ Visit <http://www.in-circuit.de/> or <http://www.radino.cc/> to download the latest In-Circuit Arduino SW Support Package

→ Unzip the downloaded file

You now have 2 folders ('hardware' and 'libraries') and a file called 'README.txt'. The content of these folders could look like the following structure:

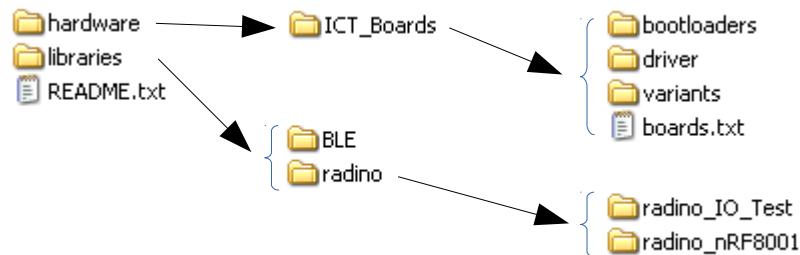

Folder 'hardware' contains all hardware information required by the Arduino IDE to recognize and program the radino  
The subfolder 'driver' contains all required USB-drivers for radino

Folder 'libraries' contains all example sketches provided for radino.

'README.txt' provides general information about installing these 2 folders properly.

→ Now copy both folders into your main Arduino-Sketch folder. As mentioned in '1. Download & Install Arduino IDE', this folder was specially defined or has one of the following default paths:

My Documents\Arduino

C:\Documents and Settings\yourUserName\My Documents\Arduino

C:\Users\yourUserName\Documents\Arduino

German computers:

Eigene Dateien\Arduino

C:\Dokumente und Einstellungen\ihrBenutzerName\Eigene Dateien\Arduino

C:\Benutzer\ihrBenutzerName\Eigene Dateien\Arduino



### 3. Connect your radino

We recommend to use the radino Leonardo for easy programming and development.

Just plug the radino into the socket on the radino Leonardo board as depicted in the right picture:

- 1.) put the radino into the socket on radino Leonardo ...
  - 2.) press it down
  - 3.) move the fastener to the middle of the radino and stop pressing on module
- The radino is connected reliable now.

**Note:** you can use the radino Leonardo to pre-program your radino modules before soldering them. The socket is very durable and able to keep up more than 1 million insertions!

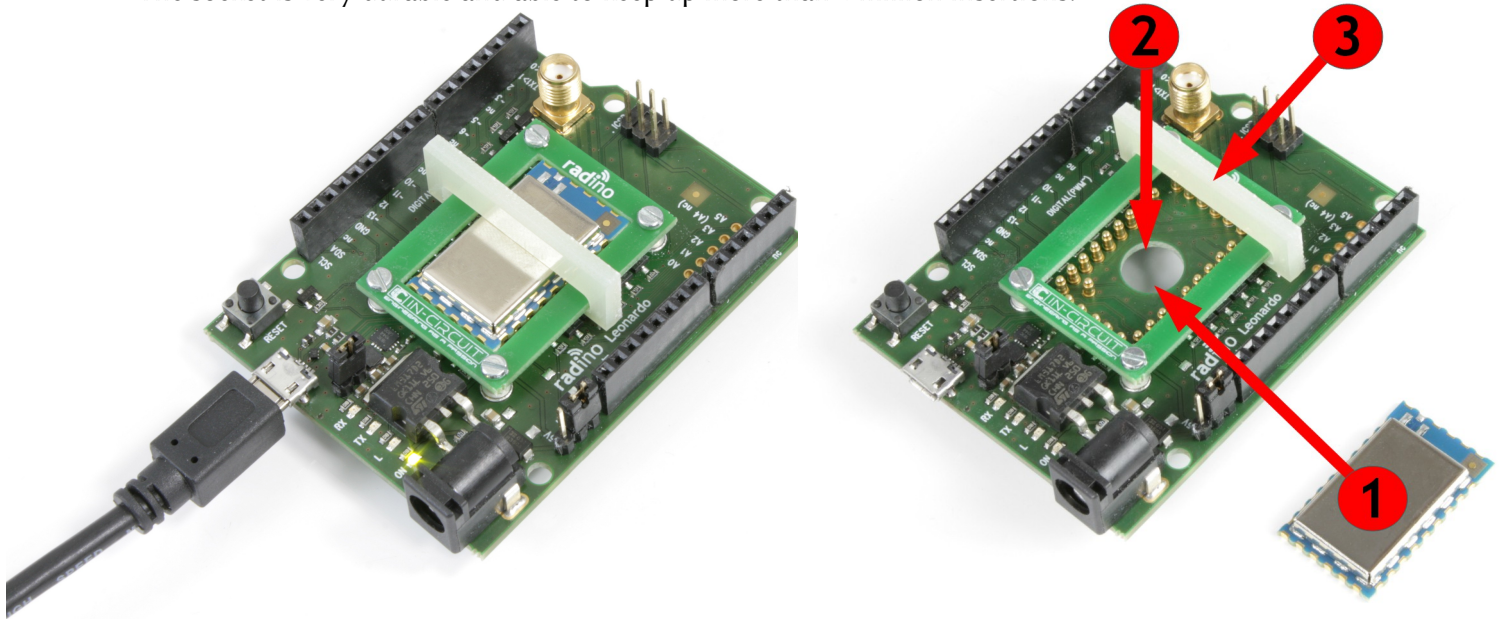

The minimal USB setup is shown in the picture below. This also represents the minimal setup for an USB-to-radio-UART-stick with radino.

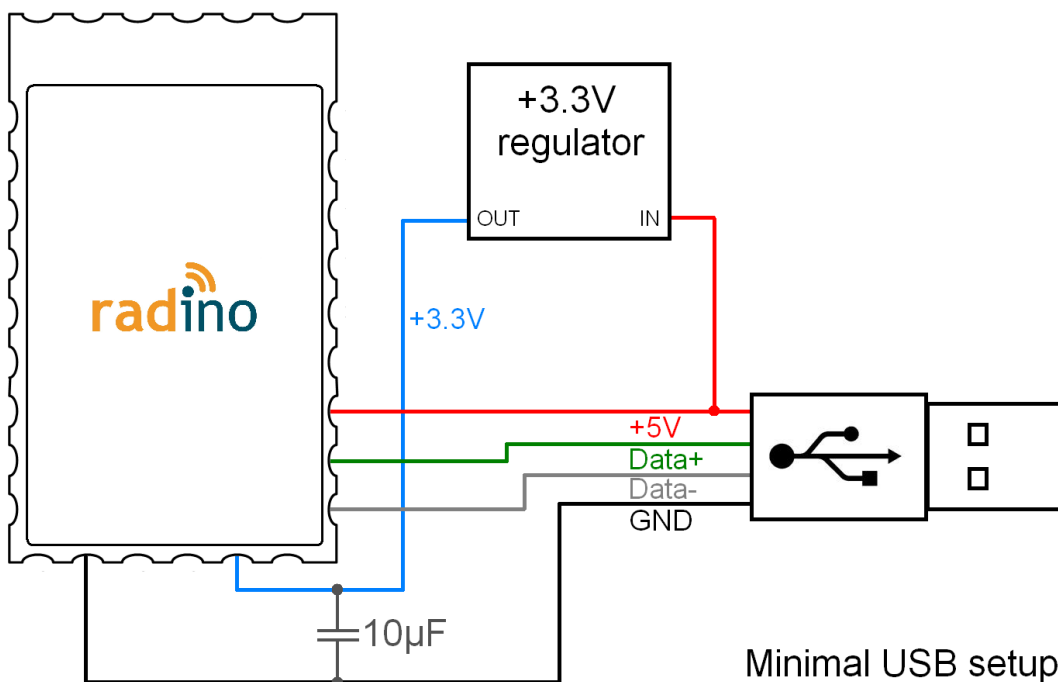

## 4. Install driver & determine serial port

After connecting radino, your computer will recognize it. When first using radino, a driver installation is required. If asked for the driver, just point the driver installer tool to the radino 'driver' folder mentioned in '2. Download & Install radino support files':

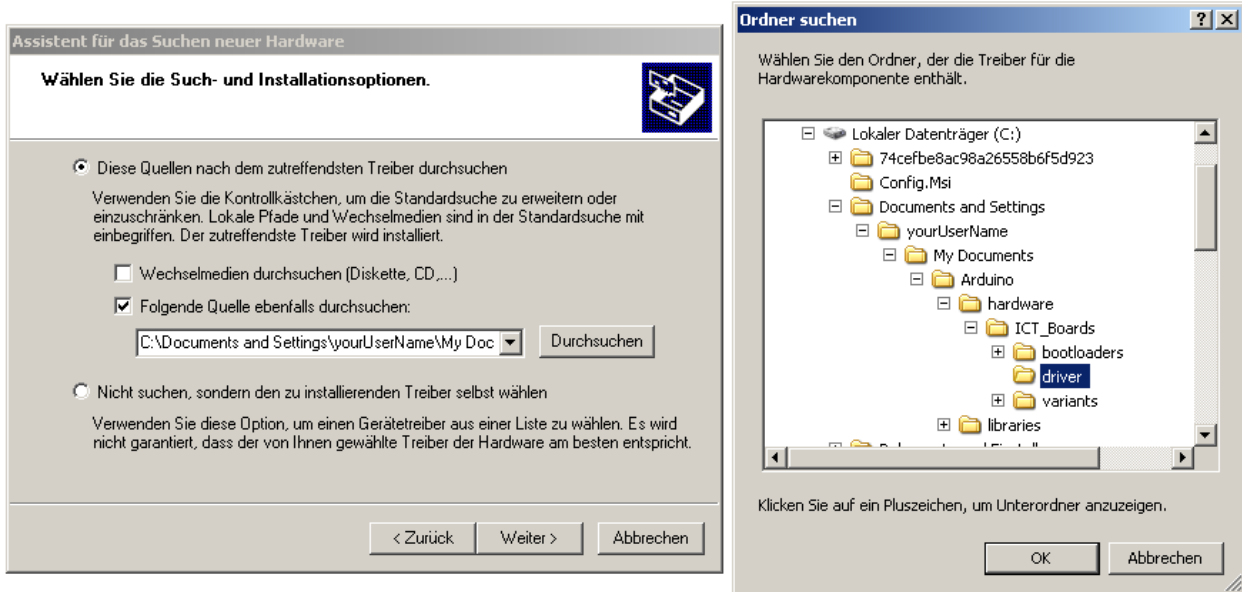

Your computer now assigns a serial port / COM-port. It's important to know the COM-port number of your radino. Therefore open the 'device manager' of Windows. (e.g. by clicking Start → Run → type 'devmgmt.msc' → Enter) The radino in this example got the COM-port COM30:

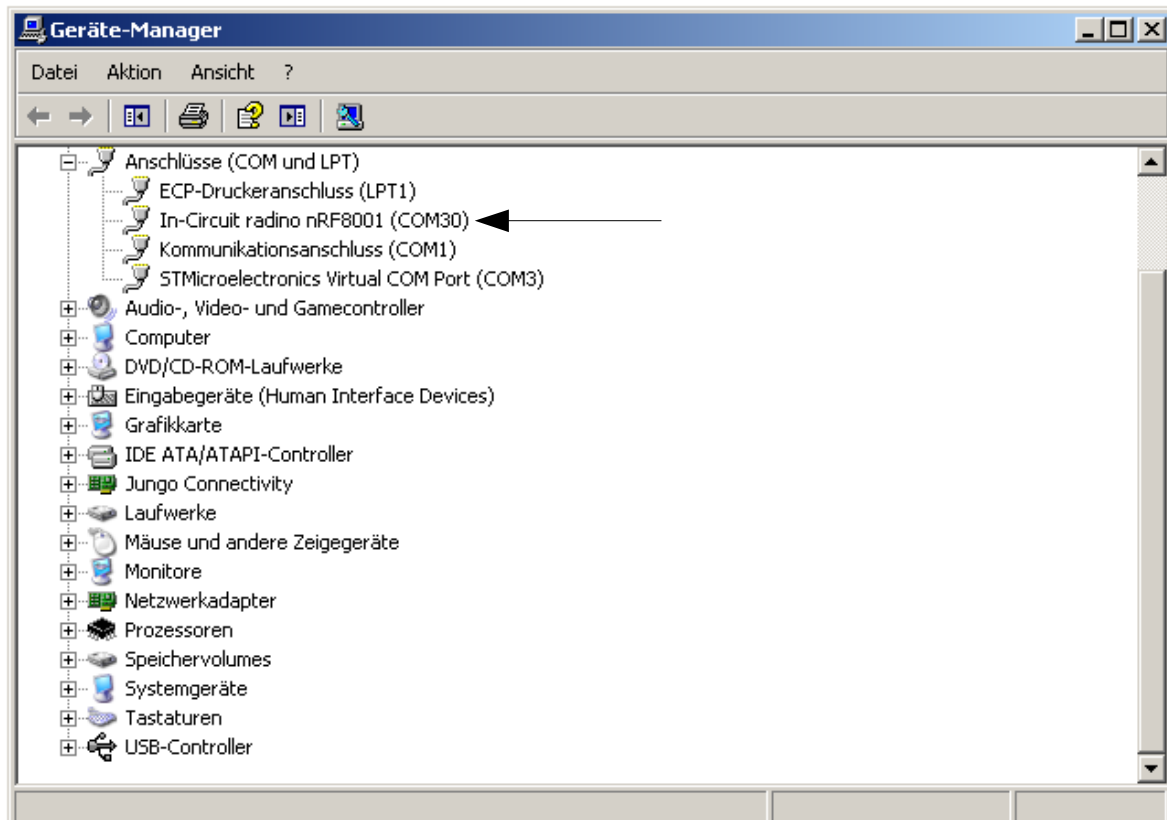

## 5. Upload your first sketch

If Arduino IDE and the support files were installed properly, it's now time to upload the first sketch to your radino

→ Open Arduino IDE and select one of the variuos available example sketches for your radino:

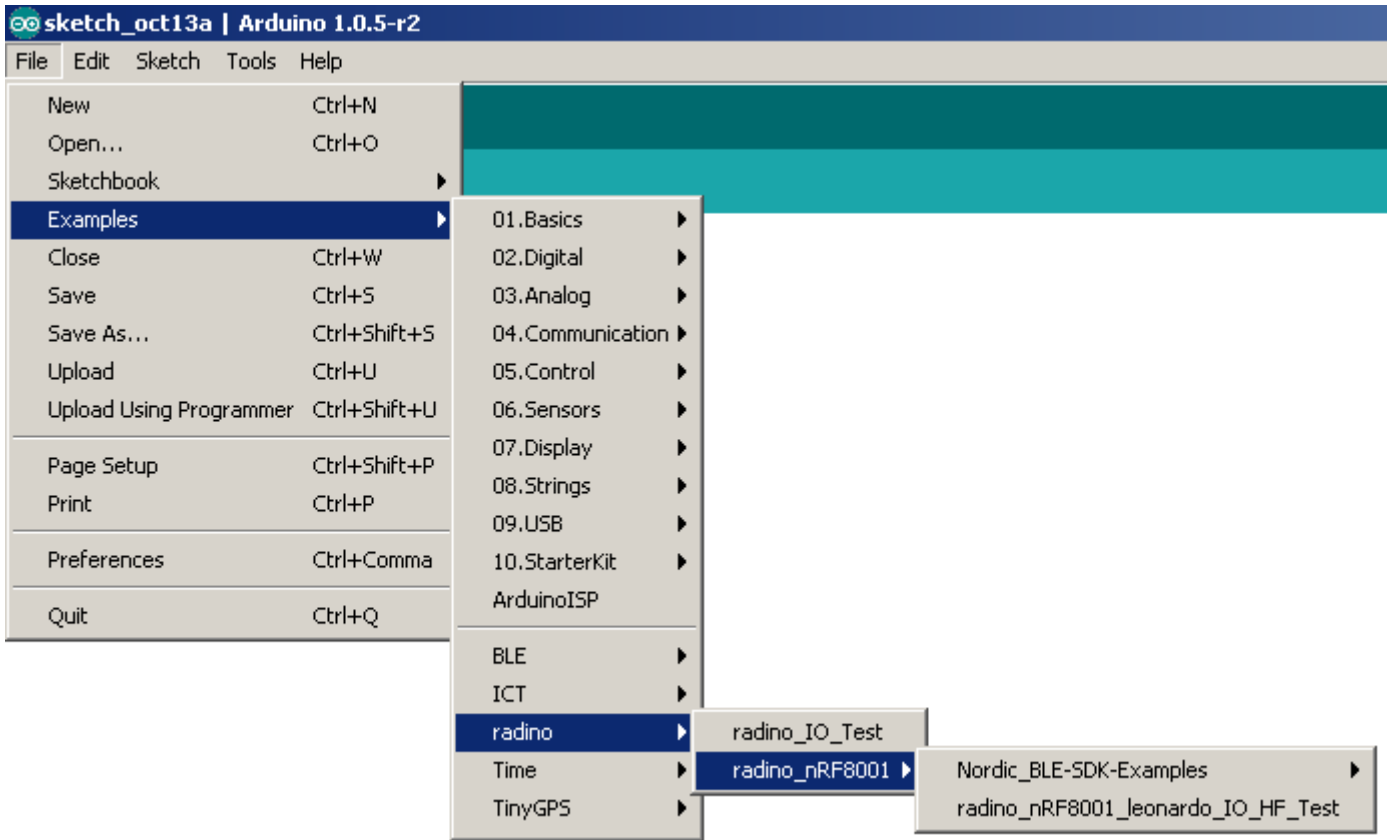

→ Now choose your corresponding radino to which you want to upload the sketch:

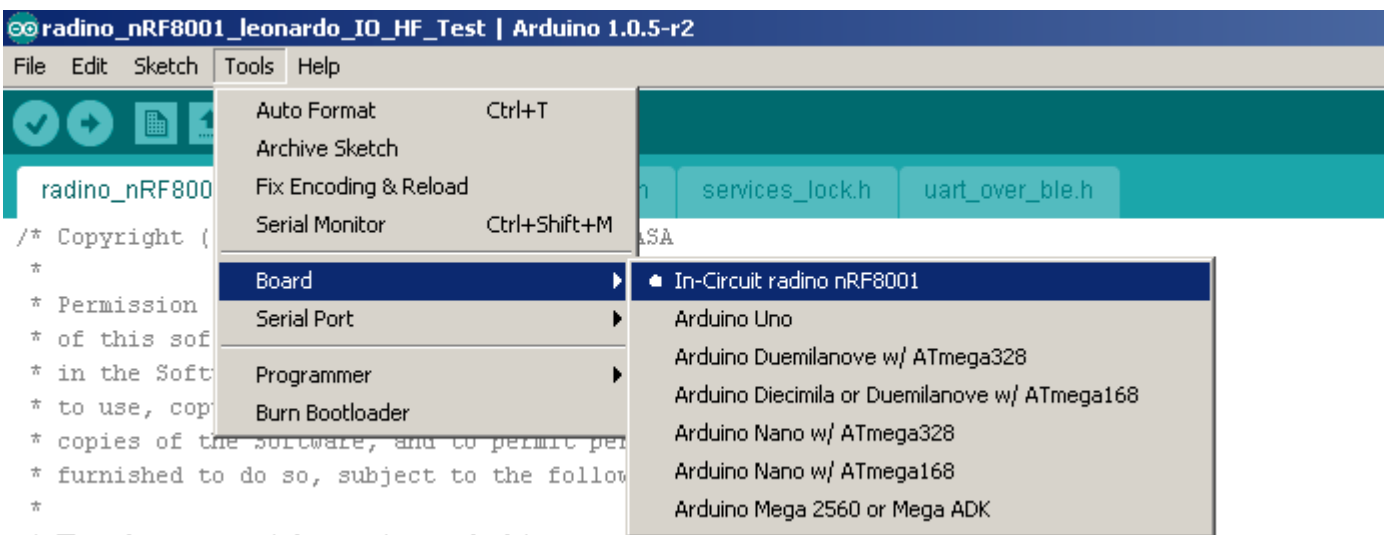

Now select the corresponding serial port / COM-port of radino that was determined in step '4. Install driver & determine serial port':

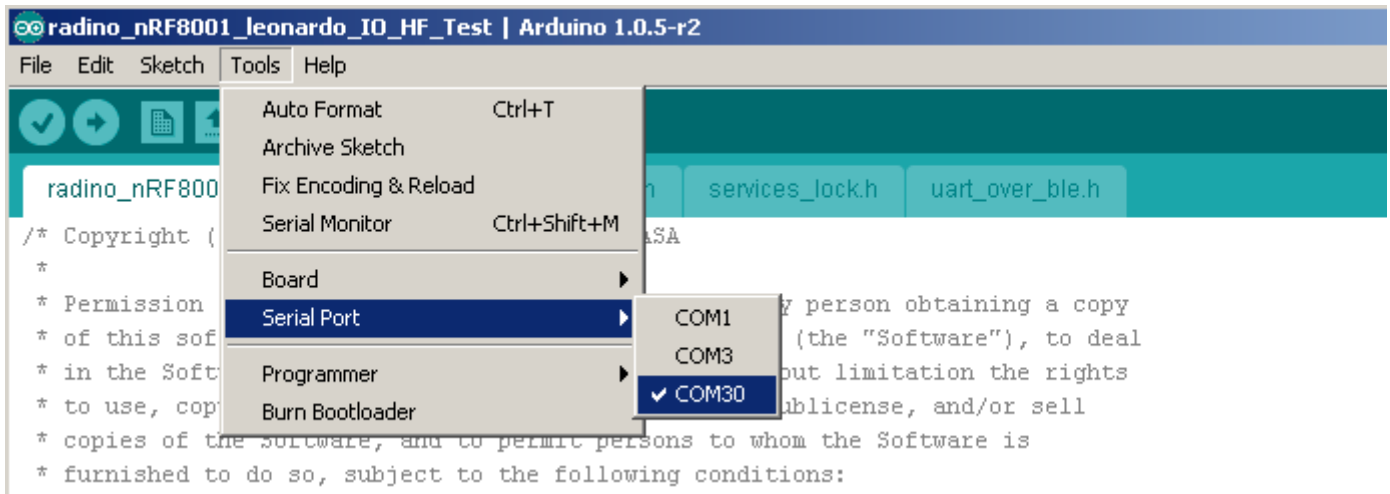

To upload your sketch simply click on the 'Upload'-Button on the top left corner.

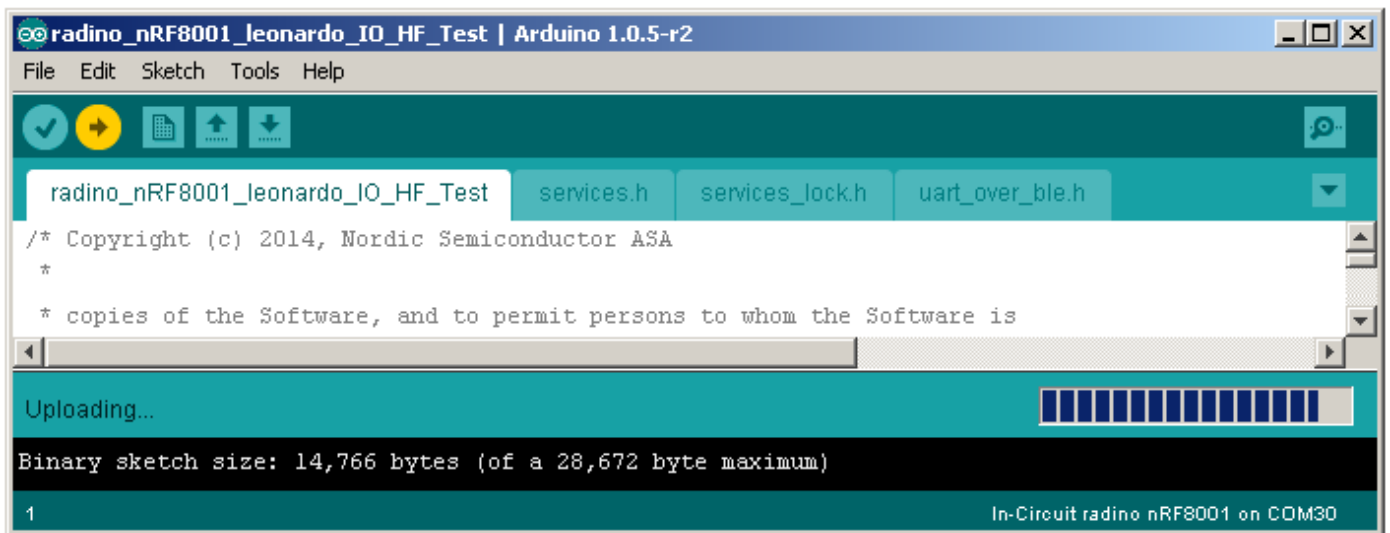

Now you can open the serial monitor to communicate with your radino:

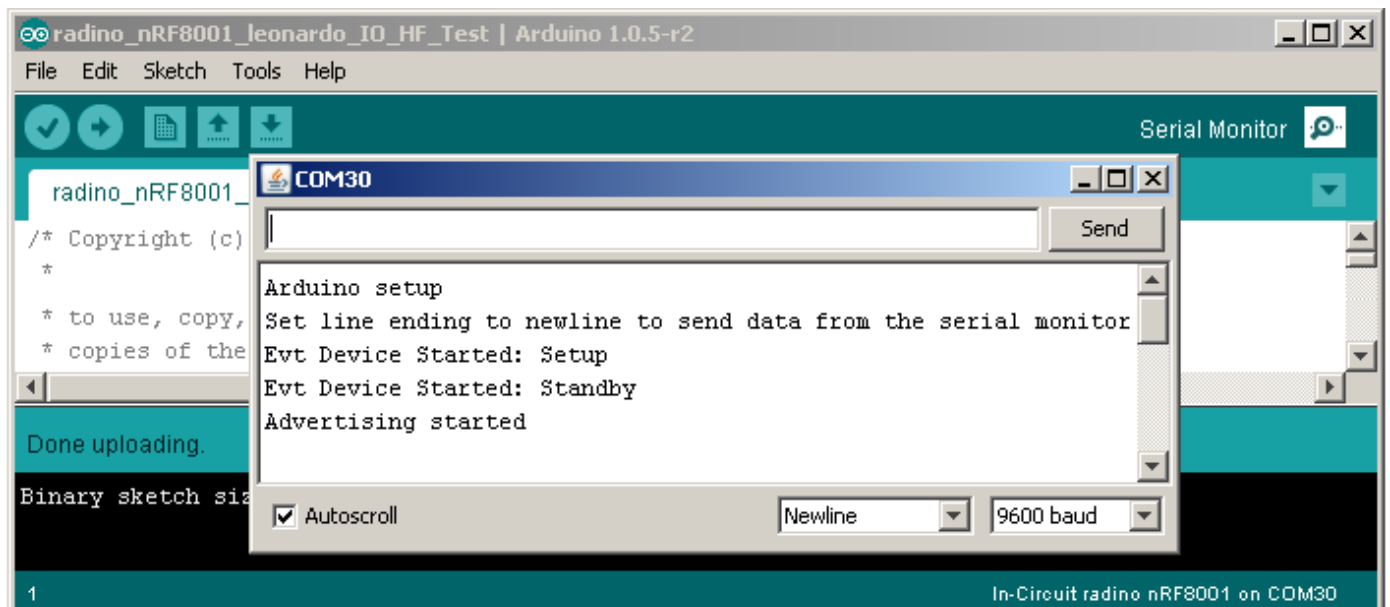

# Package Dimensions and recommended PCB Footprint

seen from top side

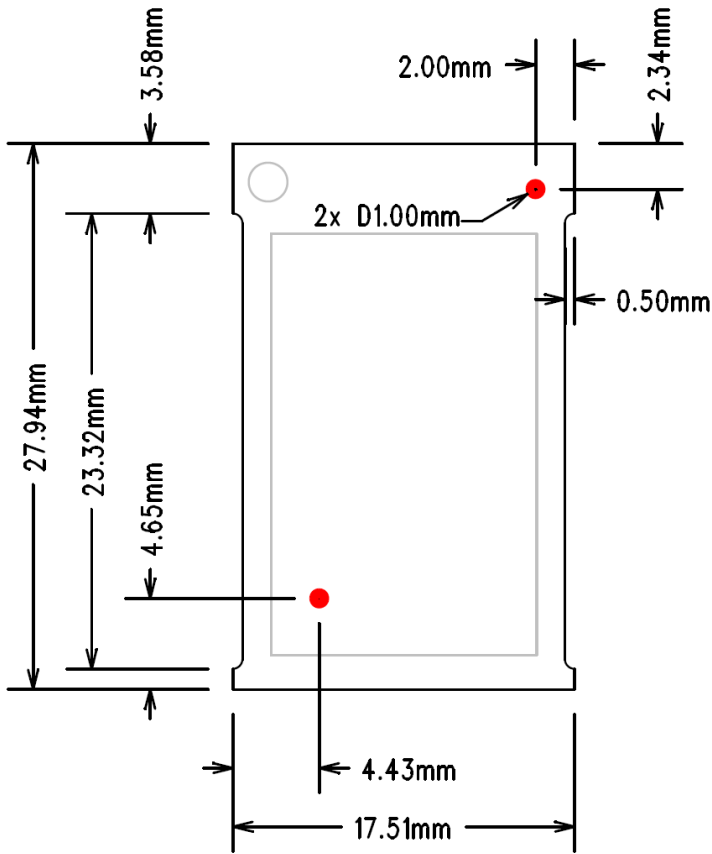

recommended footprint

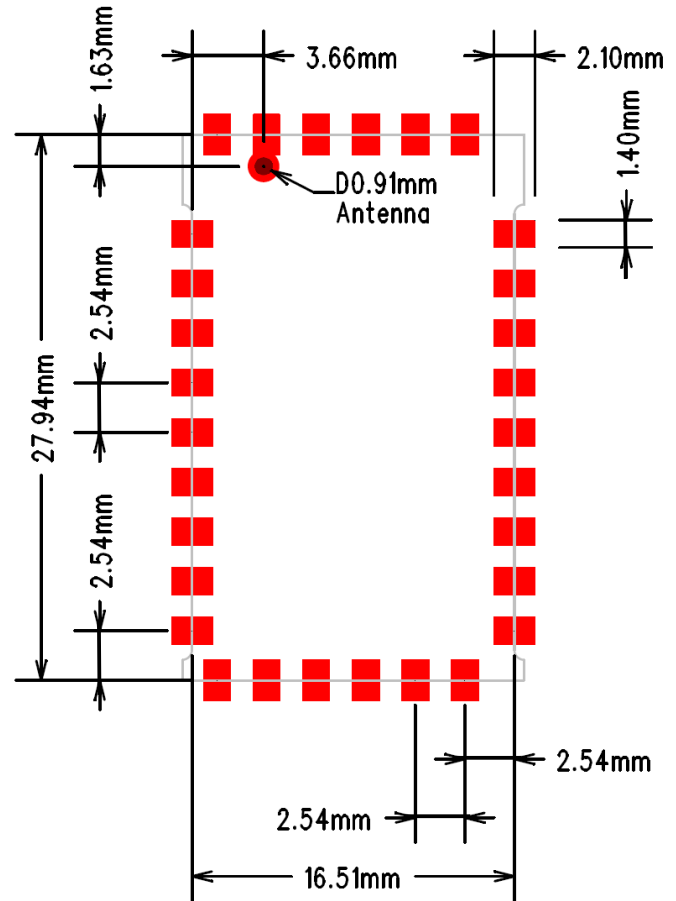

## Packaging: tape & reel specification

All radino modules come in a tape & reel package suitable for pick and place machines. Small quantities are delivered as cut-tape. There are 2 kinds of reels available with 100pcs and 500pcs per reel (see section ordering information)

Except the number of modules, all parameters are same to both reel sizes:

- 13" reel size
- 44mm tape width
- tape pocket dimensions 29mm x 19mm x 4mm
- module spacing 24mm
- 2mm hole in the middle of the module body
- 1.5mm tape holes for transport

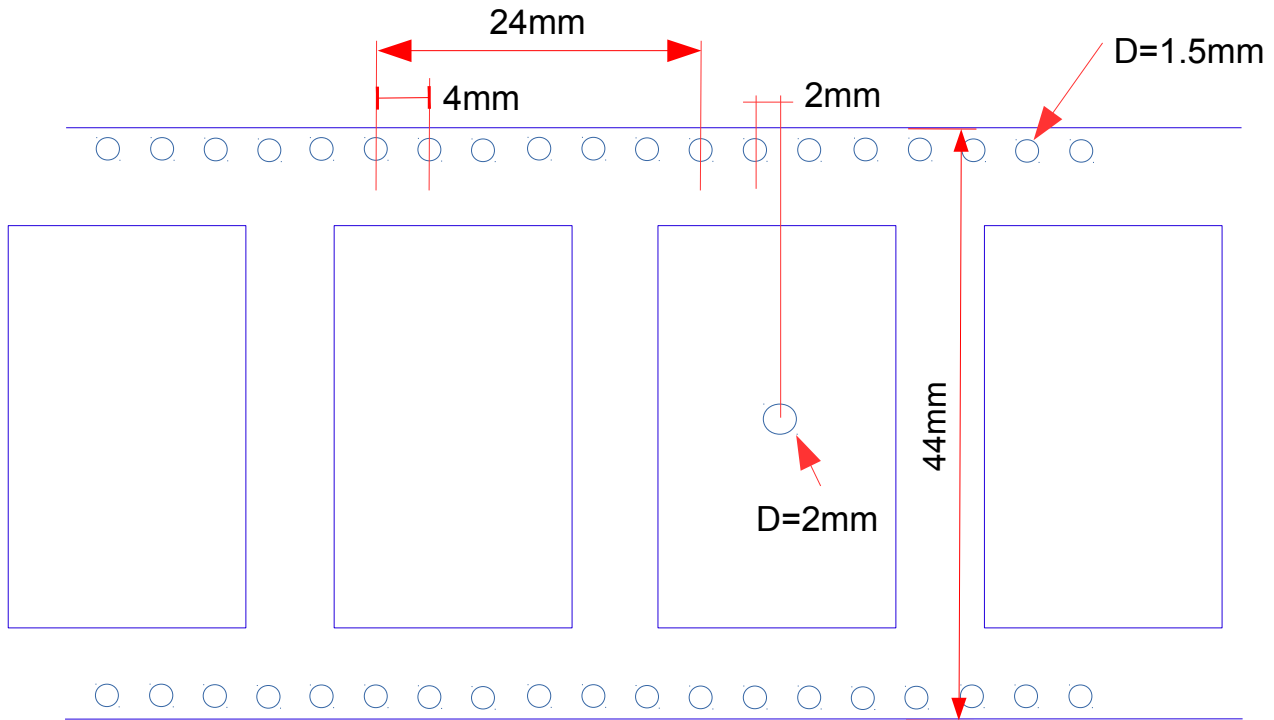

Transport direction  
(Antenna connector to the left)

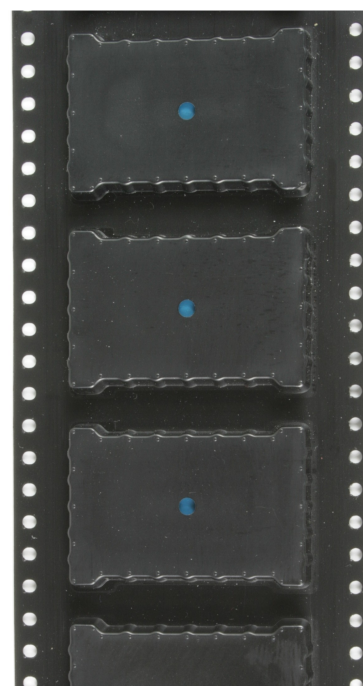
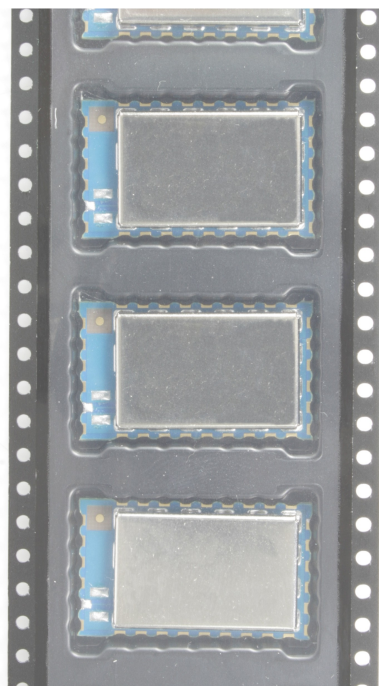

## Reflow temperature profile

The single most critical stage in the automated assembly process is the reflow stage. The reflow profile shall not exceed the following maximum ratings:

- heating gradients  $<3^{\circ}\text{C}/\text{sec}$
- peak zone temperature of the module  $<245^{\circ}\text{C}$
- time in peak zone  $<40$  sec.
- time above  $220^{\circ}\text{C}$   $<80$  sec.

Excessive temperatures, transport times and shocks during the reflow process **MUST** not be applied to the module.

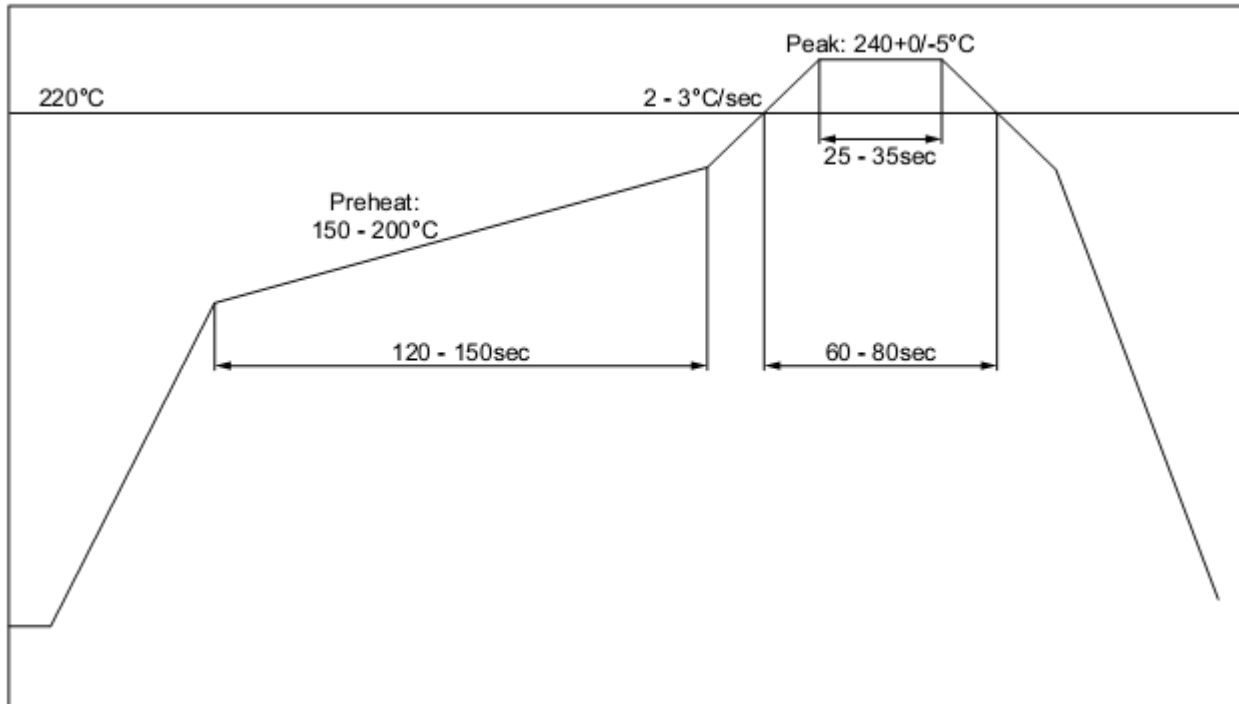

## Washability

The radino modules are wash-resistant, but are not sealed. In-Circuit recommends manufacturing without washing. If washing is needed make sure that a drying time is provided to the modules before applying electrical power. The drying time should be sufficient to allow any moisture that may have migrated into the module to evaporate, thus eliminating the potential for shorting damage during power-up or testing.

If the wash contains contaminants, the performance may be adversely affected, even after drying.

## Ordering Information

Part	Ordering Code	MOQ	Package
radino nRF8001	901.311	1	Cut Tape
radino nRF8001	901.311	100	Reel 100pcs
radino nRF8001	901.311	500	Reel 500pcs
Radino Leonardo Evaluation and Production Board	901.319	1	Single devices in Box



## Certifications

Area	Certification	Status
EU	CE	Granted
USA	FCC: ...	Pending
Canada	IC: ..	Pending
Korea	KCC-...	Pending

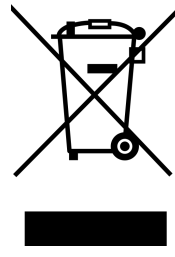

Version	Date	Changes	Editor
A	2014/10/15	Initial Version	Kormann